

# FIG.Z 06 TTTG PN16 DN15/200 F4-F5

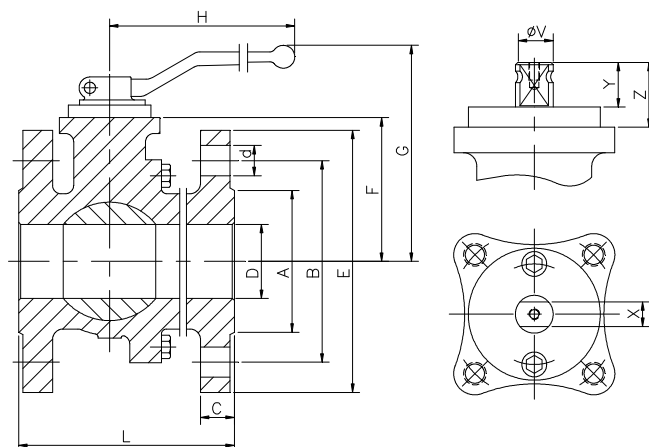
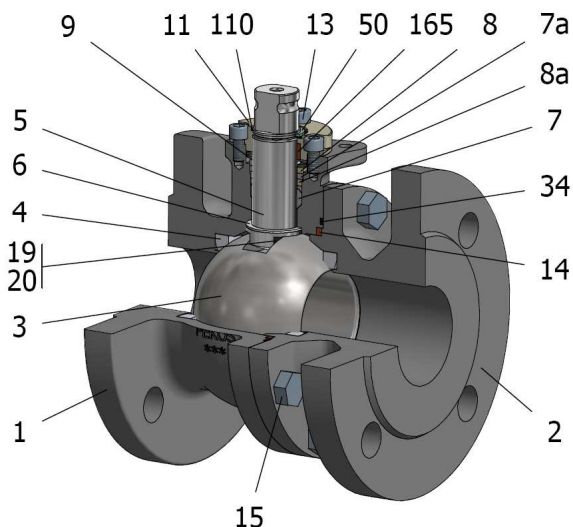

Position	Description	Material
01	Body 1	S.S. 1.4408
02	Body 2	S.S. 1.4408
03	Ball	S.S. 1.4408
04	Seat	PTFE
05	Stem	S.S. 1.4401
06	Stem seal	PTFE+FG
07	Stem packing 1	PTFE
07a	Stem packing 2	Graphite
08	Gland packing 1	S.S. 1.4401
08a	Gland packing 2	S.S. 1.4401
09	Spring washer	S.S. 1.4310
11	Cover	S.S. 1.4408
13	Cover bolt	A4-70
14	Body seal 1	PTFE
15	Body bolt	A4-70
16	Handle	WCB
17	Handle bolt	1.045(8.8)
19	Spring	S.S. 1.4401
20	Antistatic ball	S.S. 1.4401
34	Body seal 2	Graphite
50	Subjection ring	S.S. 1.4021
110	Subjection ring seal	S.S. 1.4401 Nitrided
165	Stem bearing	PTFE+FG

### General features

- Floating ball.
- Split body.
- Full bore.
- Soft seat.
- Bidirectional.
- Anti Blow out proof stem.
- Autoadjustable packing.
- Anti static device.
- Self-cavity pressure relief.

### Standards

- Top flange ISO 5211
- Flanges EN 1092-01
- Face to face EN 558
- Testing EN-12266, ISO 5208
- Design EN-12516, ISO 17292

### Official approvals

- CERTIFICATE FIRE SAFE
- TÜV.AD-MERKBLATT WO TA-LUFT
- ATEX 94-9EC
- PED 97/23/CE.
- SIL 3 CAPABLE
- EN 161/EN ISO 23553-1

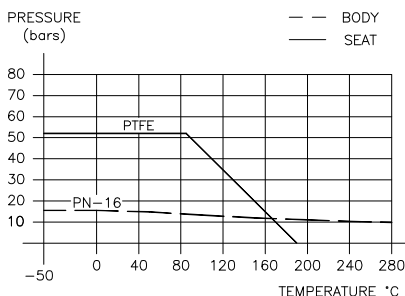

### PEKOS GROUP CERTIFICATES:

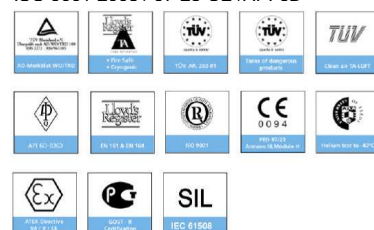

### DIMENSIONS & Technical information

DN	PN	D	L	E	A	B	C	F	H	G	V	X	Y	Z	n x d	ISO 5211	Torque	MAST	Weight
15	16	15	115	95	45	65	16	51	185	105	14	11	11	13,5	4 x 14	F05	8	43,5	3,0
20	16	20	120	105	58	75	18	53	185	107	14	11	11	13,5	4 x 14	F05	10	43,5	3,8
25	16	25	125	115	68	85	18	59	185	113	18	14	17	19,5	4 x 14	F05	14	94,5	4,7
32	16	32	130	140	78	100	18	64	185	118	18	14	17	19,5	4 x 18	F05	23	94,5	6,5
40	16	40	140	150	88	110	18	75	293	145	22	17	20	30	4 x 18	F07	31	250,4	8,2
50	16	50	150	165	102	125	20	83	293	153	22	17	20	30	4 x 18	F07	46	250,4	11,2
65	16	65	170	185	122	145	18	96	293	166	22	17	20	30	8 x 18	F07	55	250,4	16,9
80	16	80	180	200	138	160	20	114	350	205	28	22	22	40	8 x 18	F10	85	522,5	22,2
100	16	100	190	220	158	180	20	128	350	220	28	22	22	40	8 x 18	F10	110	522,5	30,0
125	16	125	325	250	188	210	22	158	740	267	36	27	35	50	8 x 18	F12	240	1073,4	56,0
150	16	150	350	285	212	240	22	175	740	284	36	27	35	50	8 x 22	F12	380	1073,4	75,0
200	16	200	400	340	268	295	24	245	750	362	48	36	40	63	12 x 22	F14	540	2544,3	134,0

\*\* Depending on service conditions.

\* Dimensions are in mm.

\* Torque & MAST are in Nm.

\* Weight is in Kilogram

\* Torque values have been measured ΔP at maximum rating at room temperature